

Technical Sheet

Rev 01 04.03.2016 - Mod 72_I9_UK

SC 60 DUO



GENERAL INFORMATION

Disposable containers for special hospital waste disposal

- | | |
|------------------------------|---|
| ▶ Closing device | Solid lid with screw top |
| ▶ Material | Plastic material (100 % polypropylen copolimer) |
| ▶ Colour | Yellow
(Plastic material coloured with masterbatch without heavy metals)
(REACH conformity) |
| ▶ Shape | Truncated pyramid |
| ▶ Lid seal | Contains no latex |
| ▶ External dimensions | 400 x 300 x 650 H mm
(lid closed) |
| ▶ Base dimensions | 330 x 235 mm |
| ▶ Weigth | 1,850 KG |
| ▶ Max. load | 25 Kg |
| ▶ Volume | 60 L. |

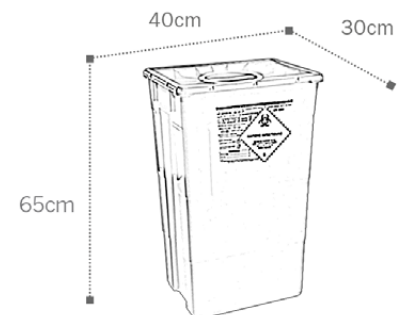

LOGISTIC DATA

- | | |
|---------------------------|---|
| ▶ Packaging | Bodies stacked onto the pallet together with lids: all shrink wrapped |
| ▶ Pcs. x pall. | 139 pcs. |
| ▶ Pall. Dimensions | 120 x 80 x 223 H cm |

CERTIFICATIONS

- ▶ Compliant to ADR - UN Approved
- ▶ Compliant to ISO 23907
- ▶ Compliant to NFX 30-505

INSTRUCTIONS

► Placement of the lid without screw lid

1° step:

Push on two opposite corners



2° step:

Push on the other two opposite corners



3° step:

Push on the edge of the short sides and insert the clips

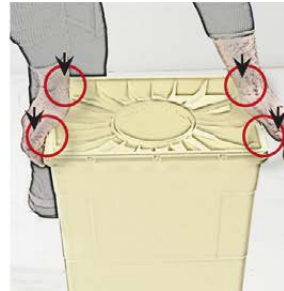

4° step:

Push on the edge of the long sides and insert the clips

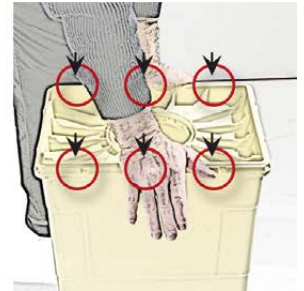

A sound ensures that the clip has been correctly inserted and the clip can be seen in the edge of the lid



The lid is sealed on the perimeter of the container

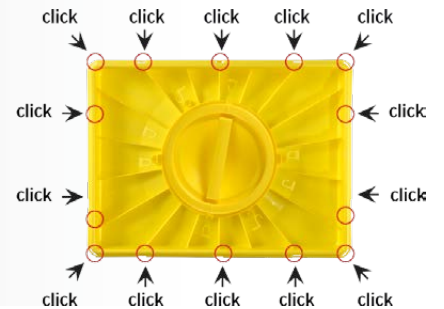

► Temporary closure

Insertion

a) place the screw lid on position as indicated on the lid

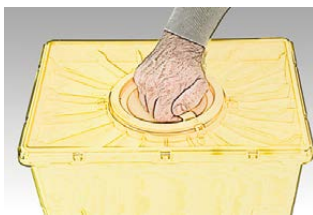

Temporary closure

b) Turn the screw lid to the left or to the right as indicated on the lid

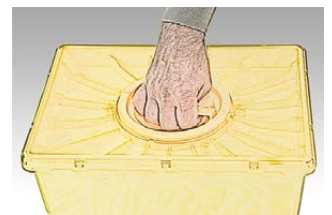

► Permanent closure

a) take off the screw lid

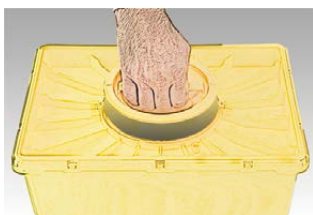

b) place the screw lid on the indicated position



c) press the screw lid firmly until it clicks



► Icons on lid SC DUO

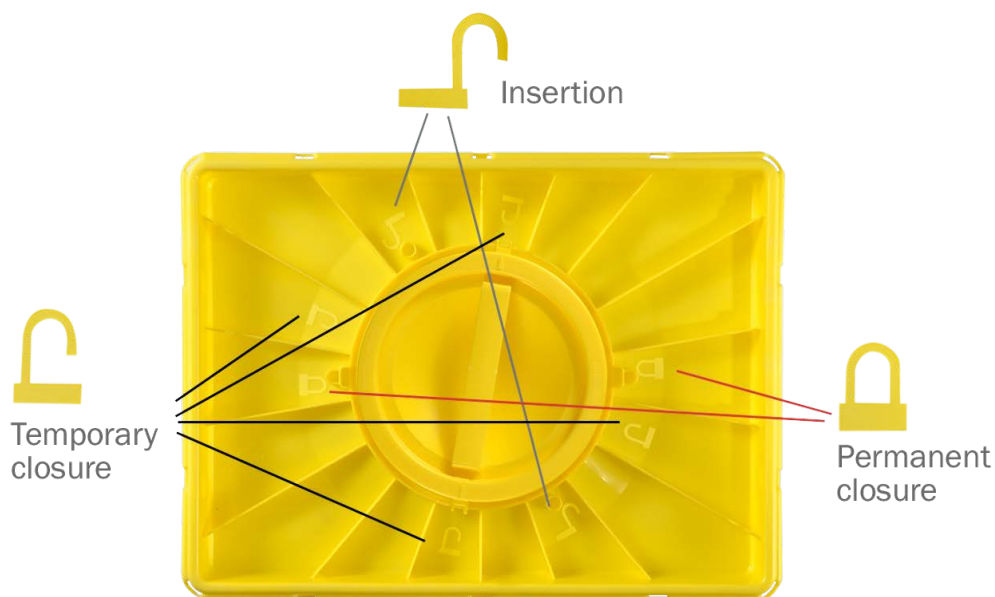

The container is watertight thanks to the glue on the screw lid



DISPOSAL

- Once full, the container must be disposed according to current law. If incinerated, the container does not release any toxic emission.

SAFETY INFORMATION

- Use the container only with its own lid
- Make sure the lid is securely fastened
- Do not exceed the filling level
- Do not try to reopen the sealed container
- Do not try to recover objects inside the container

TRANSPORT OF THE CONTAINER IN DEFINITIVE CLOSURE

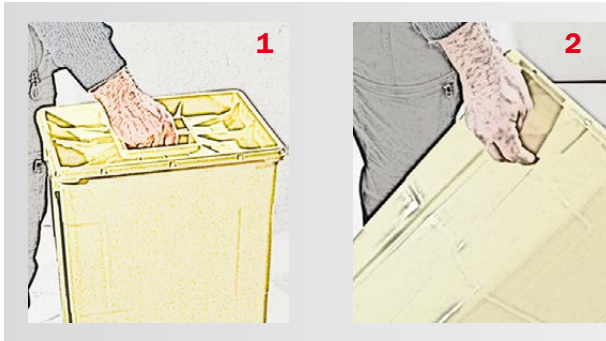

1 With the central handle

2 With the sides handles

WARNING: With lid SC DUO, use the central handle only with screw lid in permanent closure.
Do not use the central handle of the screw lid in temporary closure

ADVANTAGES

- ▶ Handle provided on the solid lid for safe handling
- ▶ Container equipped with two side ergonomic handles
- ▶ Handles are tested for the double of maximum load
- ▶ Very stable containers, stackable with the best logistic solution to reduce the transport costs as well as the stocks costs
- ▶ Stackable up to 3 m. full load
- ▶ High shock resistance at both low and high temperature
- ▶ High perforation resistance
- ▶ Easy to use
- ▶ Safe permanent closure
- ▶ No noxious gas released during the incineration process