

# Little Junior QCPR Upgrade Kit

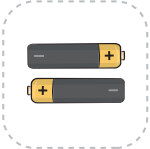





+

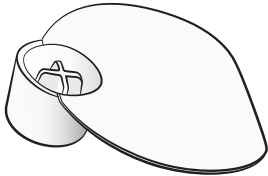
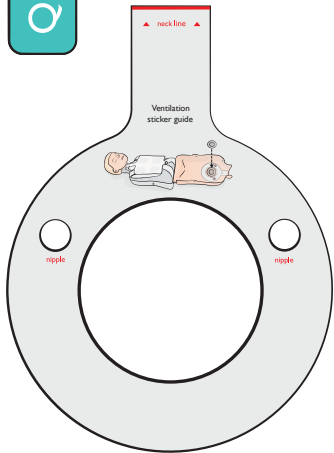
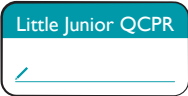
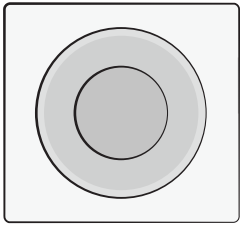
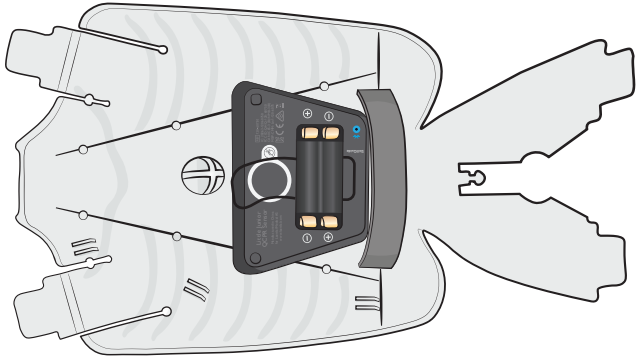

1

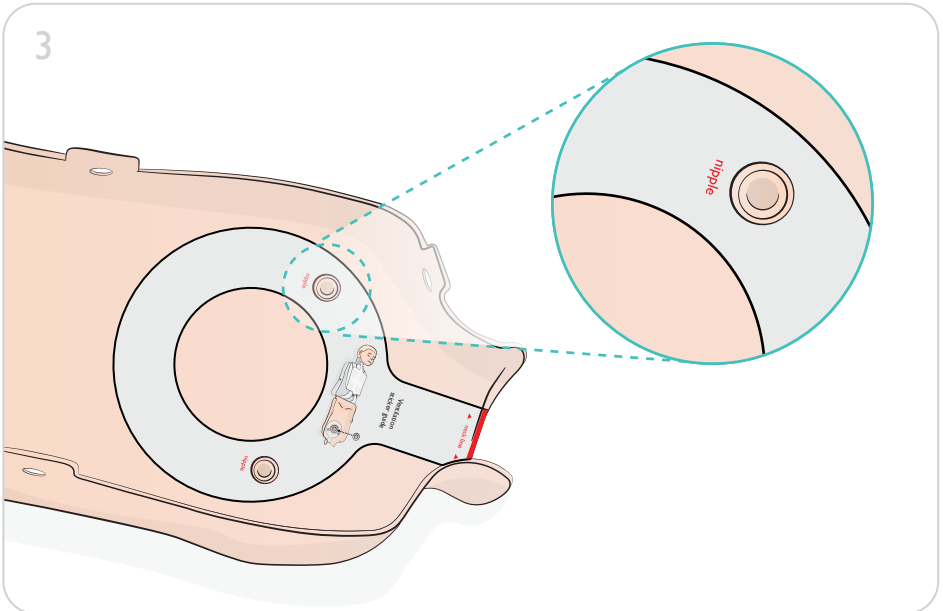
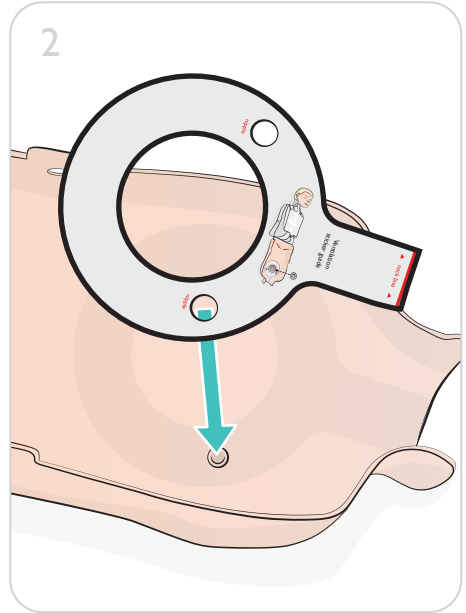
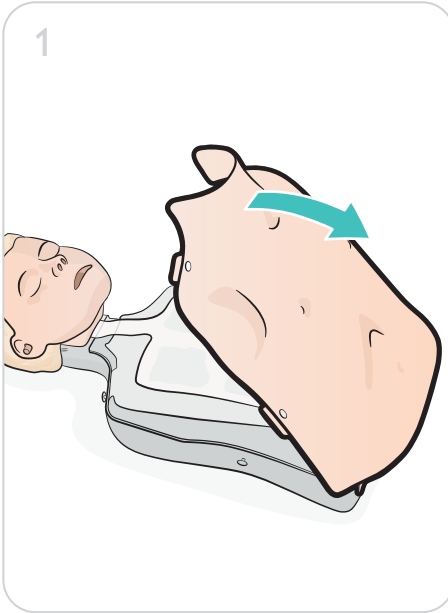

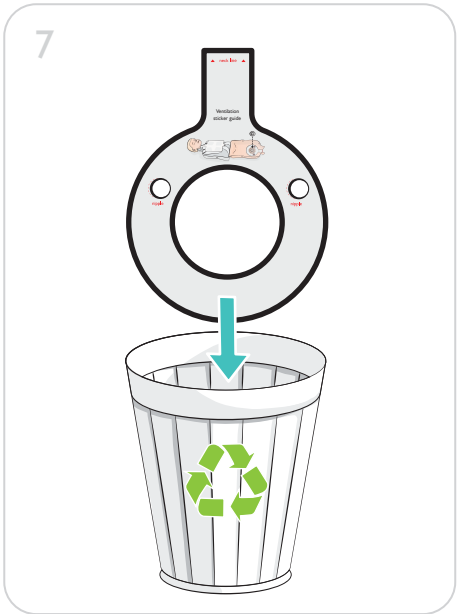
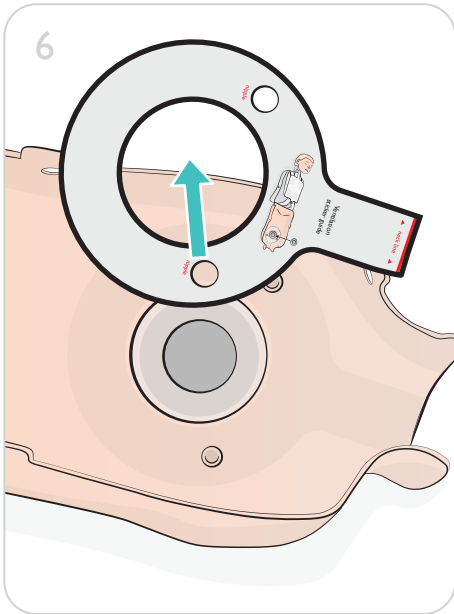
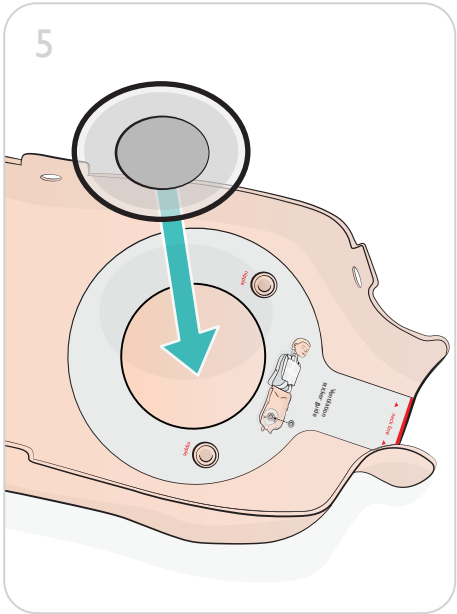
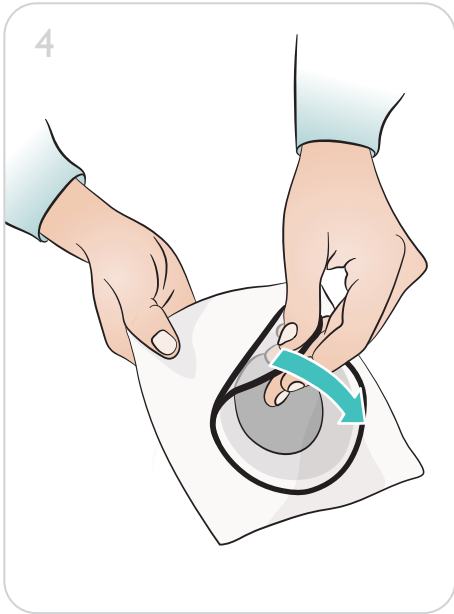

# 2

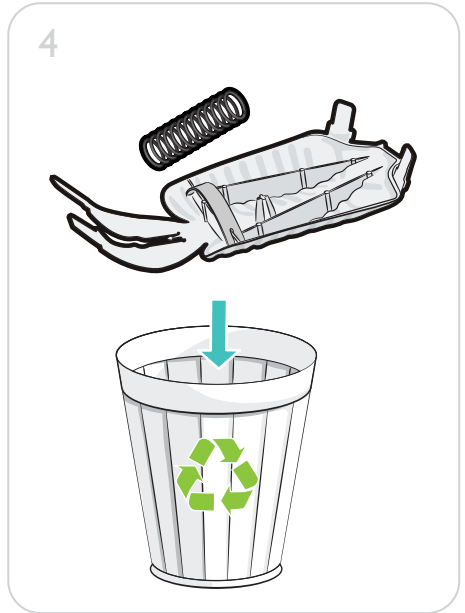
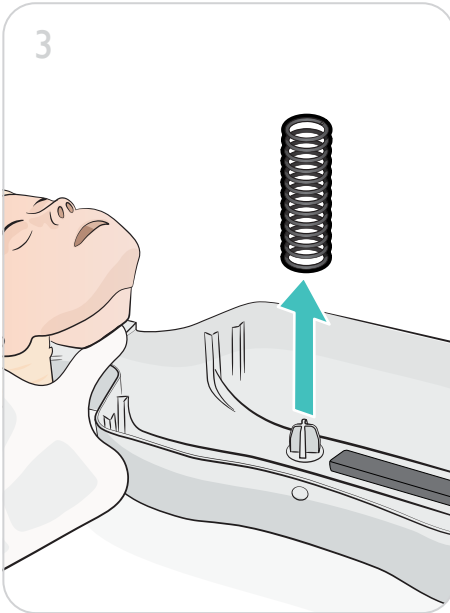
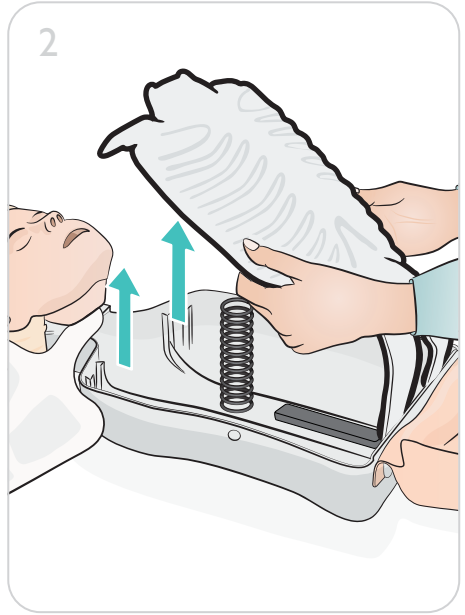
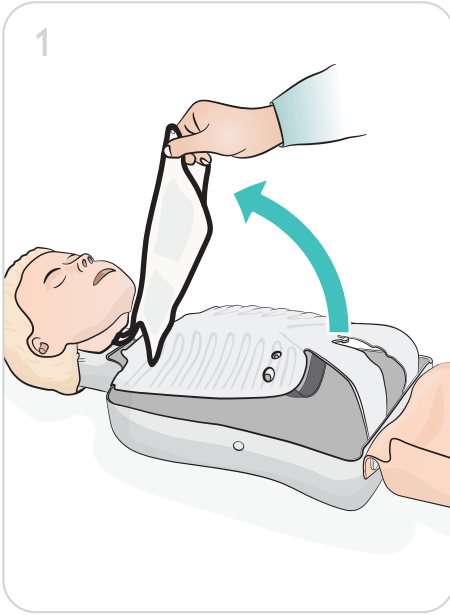

1

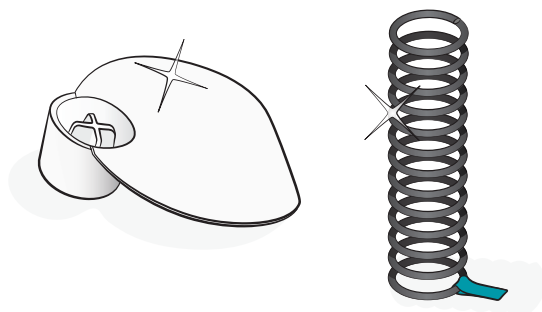

2

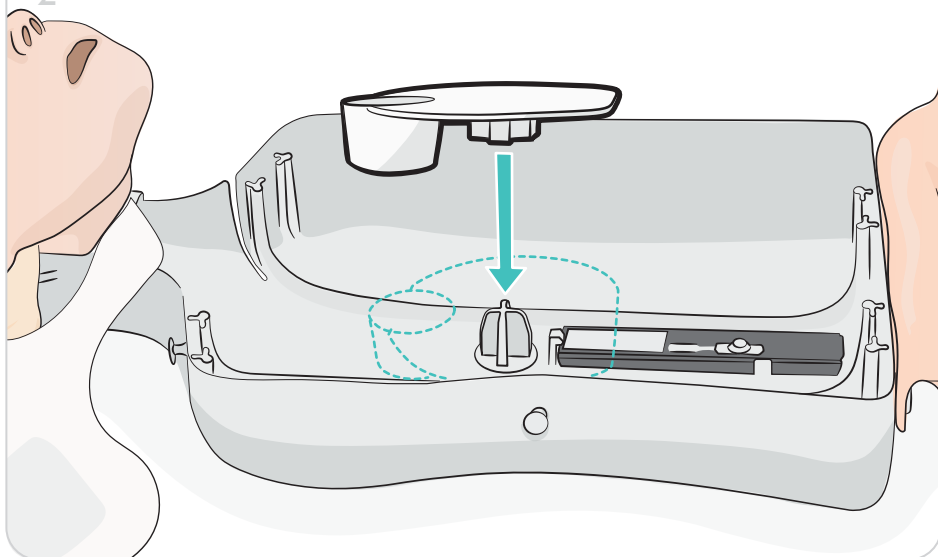

3

3

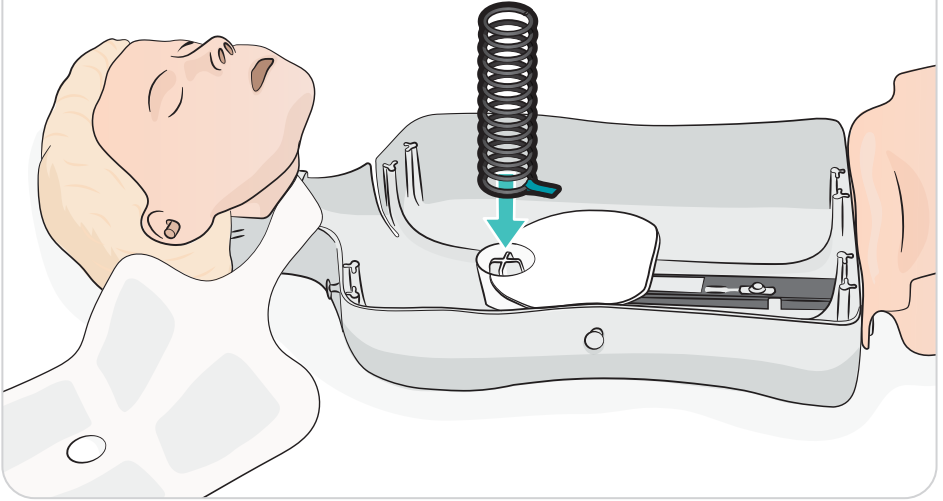

4

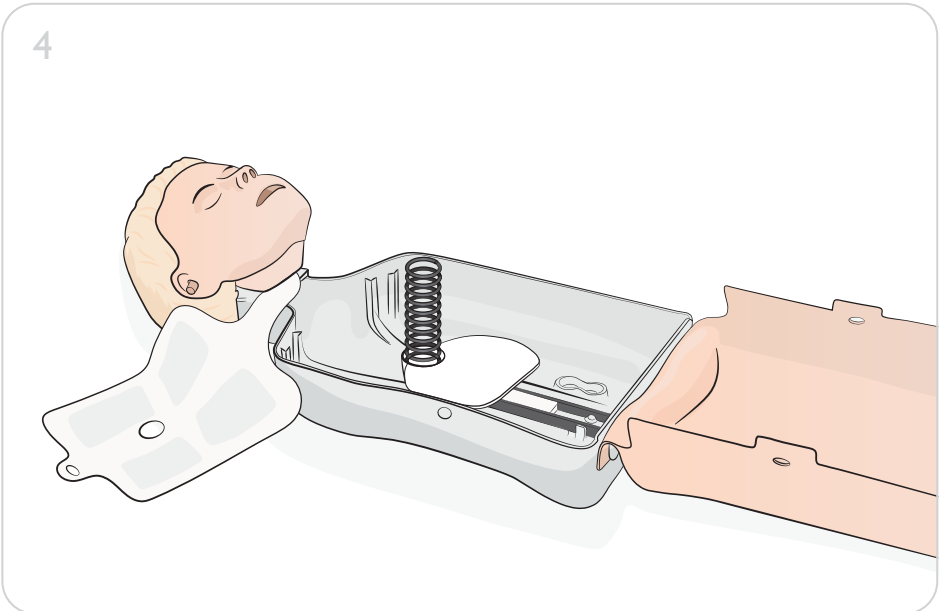



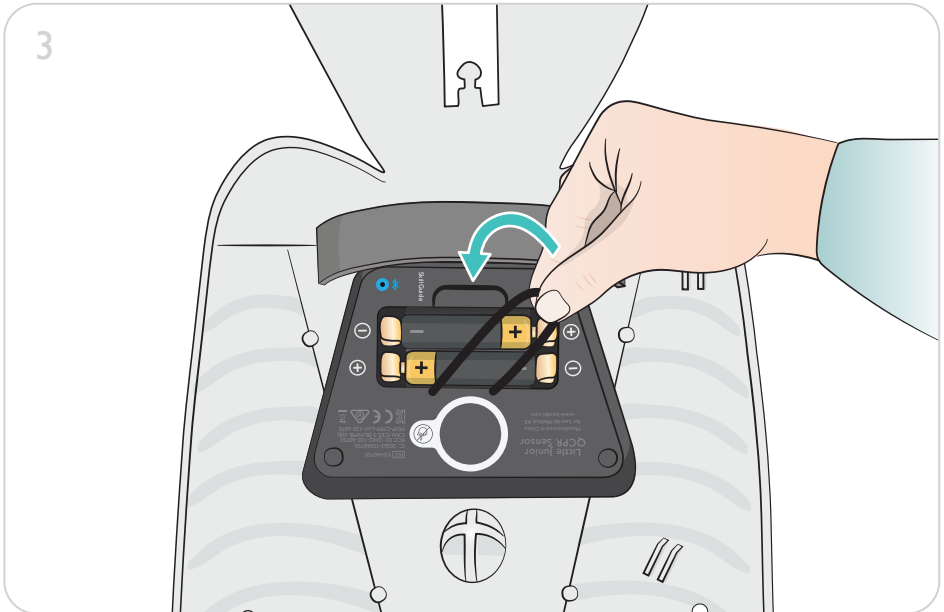
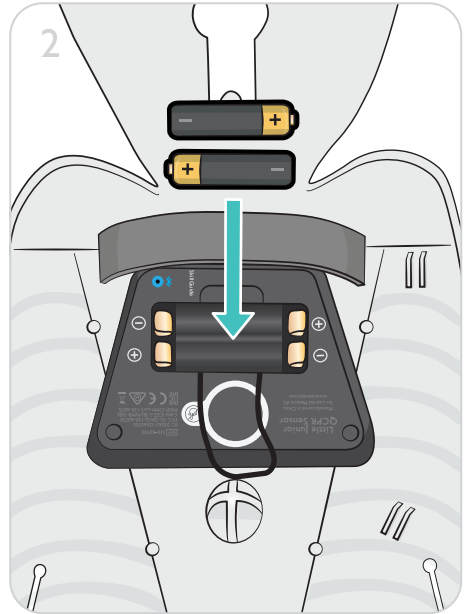
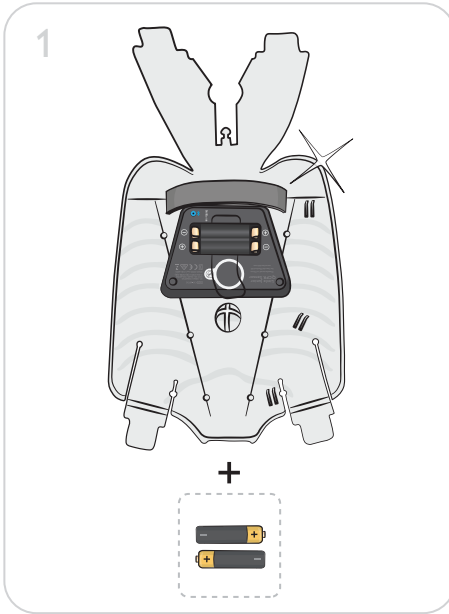

4

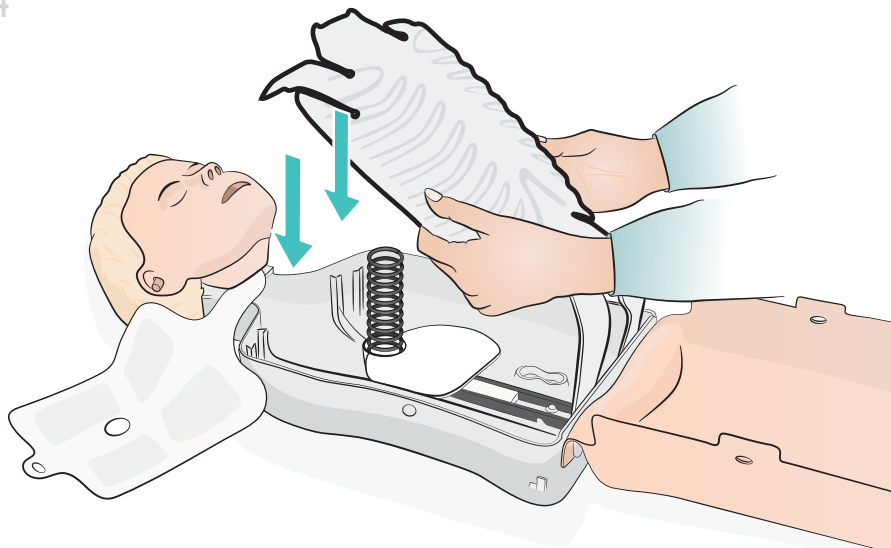

5

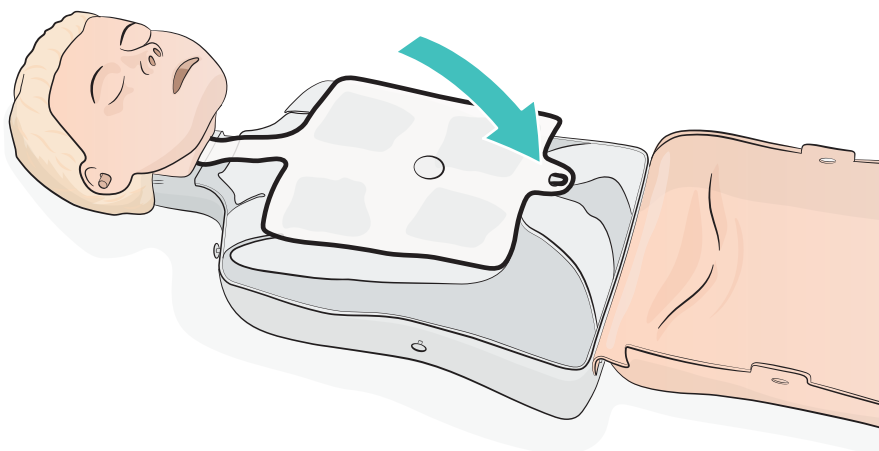

1

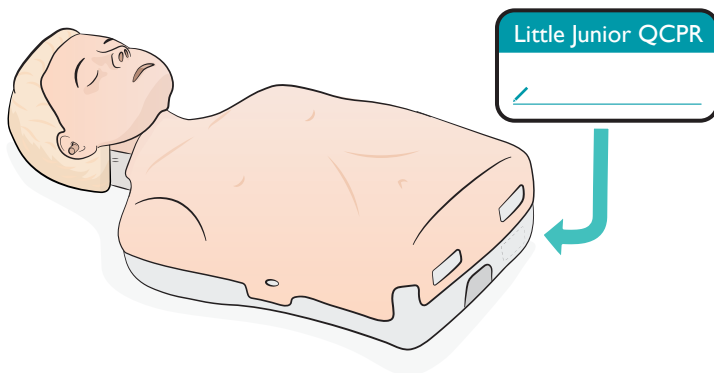

2

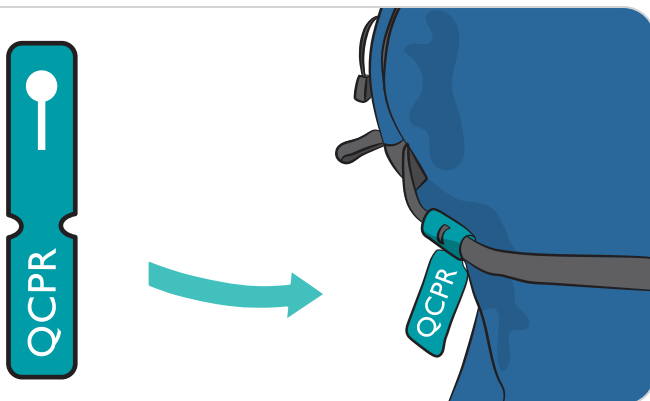

3

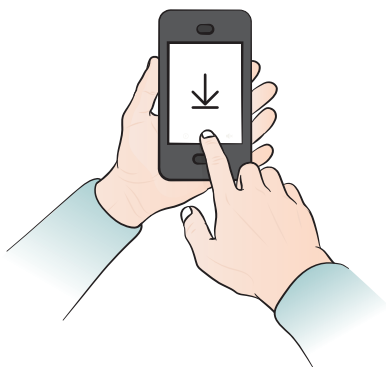

QCPR Learner  
QCPR Instructor



QCPR Learner

© 2018 Laerdal Medical AS. All rights reserved.

Manufactured in China for:  
Laerdal Medical AS  
P.O. Box 377,  
Tanke Svilandsgate 30, 4002 Stavanger, Norway  
T: (+47) 51 51 17 00

Printed in China

20-12890 Rev B

[www.laerdal.com](http://www.laerdal.com)



**Laerdal**  
helping save lives